

Features

- 0.35 gpm (1.3 lpm) maximum flow rate at 60 psi (4.14 bar)
- Vandal-resistant aerator
- Factory-set 30-second maximum continual run cycle
- 24" (610 mm) flexible supply hose for easy installation
- 6-3/16" (157 mm) spout reach
- Less drain

Material

- Brass

Technology

- Electronic Insight™ sensor technology for accurate and consistent activation
- Includes 3.6 volt Hybrid Energy Cell

Installation

- Single-hole mounting
- Above-counter valve for easy installation and maintenance



ADA

CSA B651

OBC

Codes/Standards

ASME A112.18.1/CSA B125.1

NSF/ANSI/CAN 372

All applicable US Federal and State material regulations

DOE - Energy Policy Act 1992

California Energy Commission (CEC)

ADA

ICC/ANSI A117.1

CSA B651

OBC

KOHLER® One-Year Limited Warranty

See website for detailed warranty information.

Available Colors/Finishes

Color tiles intended for reference only.

Color	Code	Description
-------	------	-------------



CP

Polished Chrome

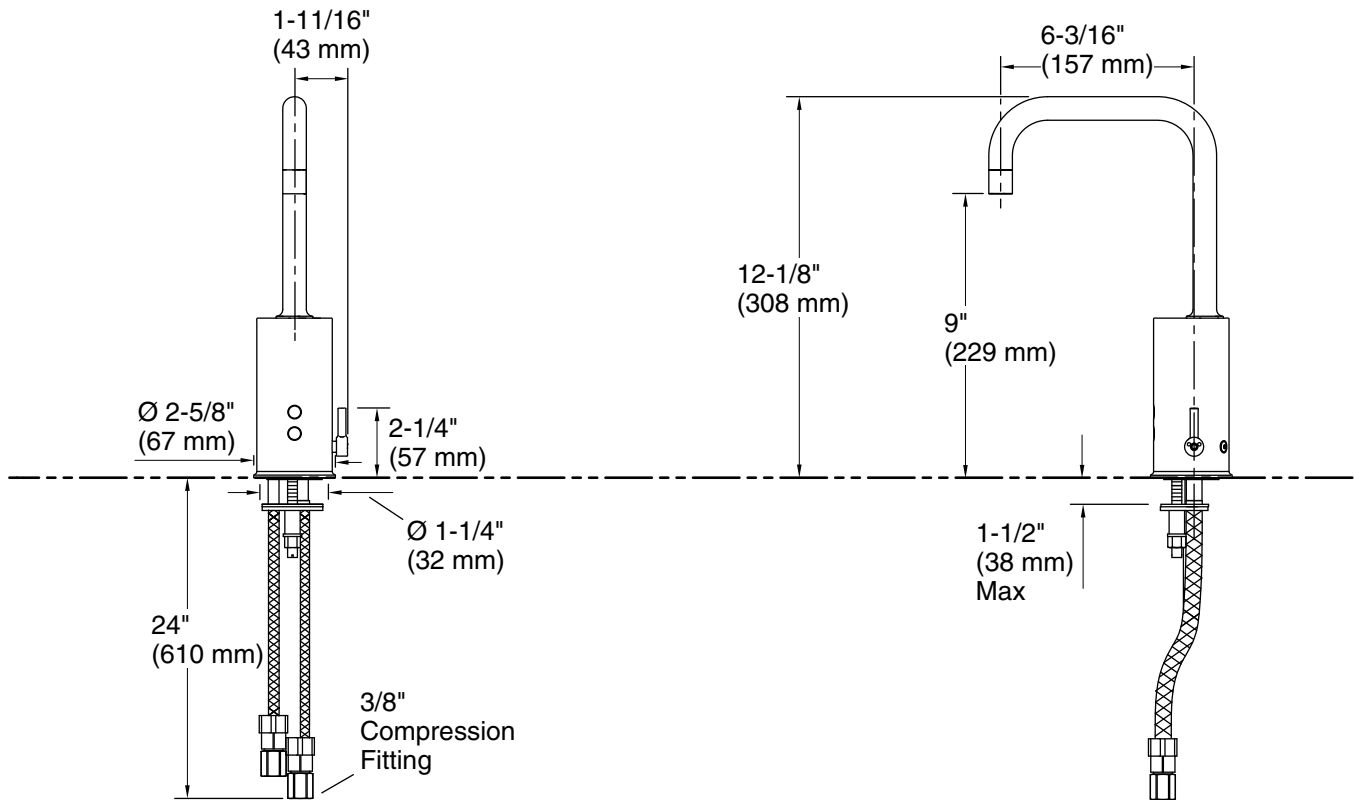

Technical Information

All product dimensions are nominal.

Faucet:

Flow rate: 0.35 gal/min (1.3 l/min)

Drain included: No

Drain with overflow: No

Spout:

Spout reach: 6-3/16" (157 mm)

Handshower:

Rated maximum flow: 0 gal/min (0 l/min)

Notes

Install this product according to the installation instructions.

ADA, OBC, CSA B651 compliant when installed to the specific requirements of these regulations.